

Live Better



YORK

FURNISHING FABRICS SINCE 1988

FOREST[®]
DRAPERY HARDWARE



DOMOTICS
READY



APP
CONTROL



WIRELESS
REMOTE



CORDED
CONTROL



FOREST ROMAN BLIND Series

Elegantly shaped aluminium profile with integrated Velcro Tape

THE WORLD
BEHIND
YOUR
CURTAINS



FOREST BLIND CONTRACT SYSTEM - BCS®



Another solution of Forest is the motorized roman blind 'BCS®-system', developed especially for taller window frames and heavier fabrics. The tubular motor in the system is 220 Volt and available in variable voltages as required. A powerful 121 Watt motor is standard, capable of lifting blinds of up to 13 kg; other motor types - capable of up to 26 kg - are available upon request. The cord coils can hold 5.5 meter of cord.

The Forest roman blind BCS® system is suitable for all current control systems and incorporates a unique, patented cord braking system. If, for any reason, the roll down action of a blind is obstructed, the motor automatically trips out to prevent the blind leaning and the cord breaking.

FOR USE IN

Domestic and/or project market, or at any location where a high quality and smooth operated motorized blind system is requested.

PRODUCT INFORMATION

- Motorised roman blind system.
- For all types of medium and heavy weight draperies.
- Elegantly shaped aluminium profile, with Velcro Hook Tape
- Available width: 5.80 meter (19”).
- Application width: min. 65 cm & max 5.50 meter (18”).
- Simple and quick installation with Smart Klick® bracket.
- Cords are easy to remove; very useful when you want to wash or dry cleaning the fabric.
- Can be controlled by wall switch, remote control (high frequency).
- Easy to connect to building automation systems.
- Easy to connect with third party Apps (Apple Homekit or Google Assistant) by the Forest Wireless Connector.
- Cord Drums can be placed on every position in the profile.
- Maximum fabric weight per cord roll: 4 kg.
- Tubular motor also available with internal Multi receiver and electronic limit setting.
- Track finish: aluminium, chromated, powder coated.
- Warranty Manual System: 10 year.
- Warranty Motorised System: 5 year.

CONTROL OPTIONS





PROFILE

- Weight 1092 gr/mtr
- Aluminium extrusion 6063 TS
- Size 63 x 74 mm (2.4" x 2.9") •
- Colour available: white

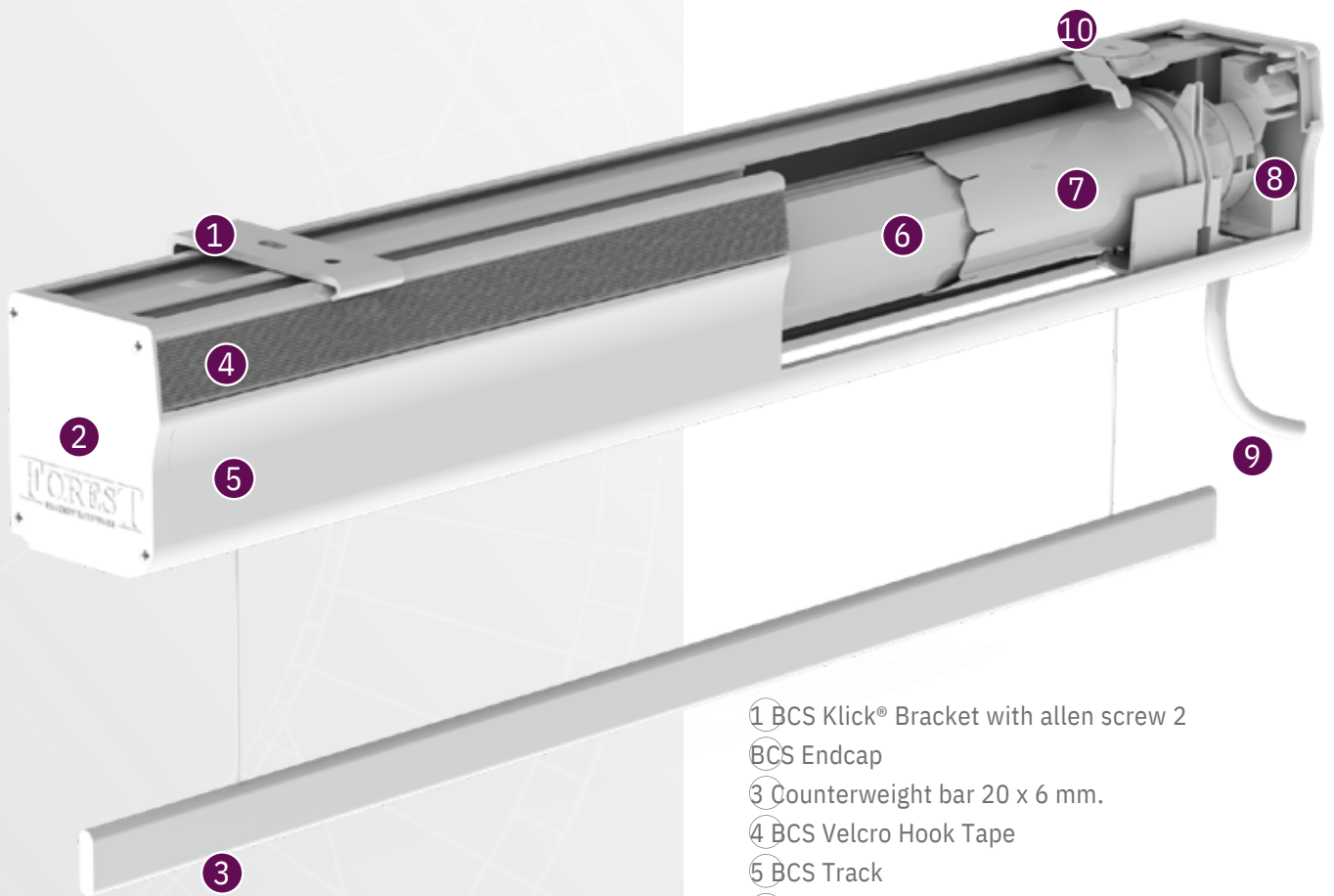
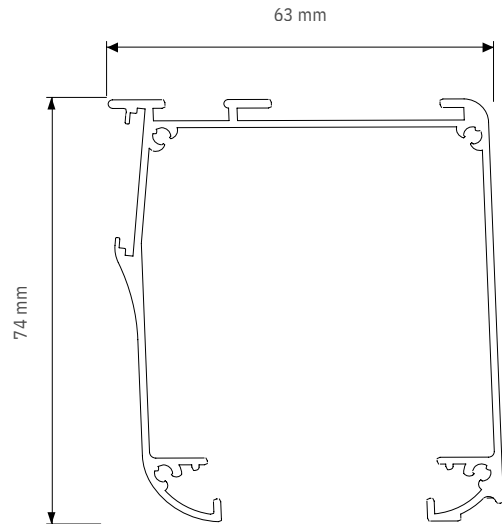

- 1 BCS Klick® Bracket with allen screw 2
- 2 BCS Endcap
- 3 Counterweight bar 20 x 6 mm.
- 4 BCS Velcro Hook Tape
- 5 BCS Track
- 6 BCS Tube 8-angular
- 7 BCS Cord Roll House Complete
- 8 BCS Centre Support
- 9 Forest Tubular Motor
- 10 Ceiling Swivel Bracket

FOREST BLIND CONTRACT SYSTEM - BCS®



SPECIFICATIONS

| Type | Strength | Speed | Weightload | Noise level | Internal Control options |
|---------------|----------|-------|------------|-------------|--|
| 6/28/S 6 Nm | 28 rpm | 13 kg | < 44 dB(A) | No < | Home Automation / Forest Multi Receiver Wall Switch |
| 6/20/SQ 6 Nm | 20 rpm | 13 kg | 40 dB(A) | No < 44 | Home Automation / Forest Multi Receiver Wall Switch |
| 13/14/S 13 Nm | 14 rpm | 26 kg | dB(A) | No < 44 | Home Automation / Forest Multi Receiver Wall Switch |
| 6/28/E 6 Nm | 28 rpm | 13 kg | dB(A) | Yes < 40 | Forest Remote / Wireless Wall Switch / Forest Wireless Connector |
| 6/20/EQ 6 Nm | 20 rpm | 13 kg | dB(A) | Yes < 44 | Forest Remote / Wireless Wall Switch / Forest Wireless Connector |
| 13/14/E 13 Nm | 14 rpm | 26 kg | dB(A) | Yes | Forest Remote / Wireless Wall Switch / Forest Wireless Connector |

MOUNTING

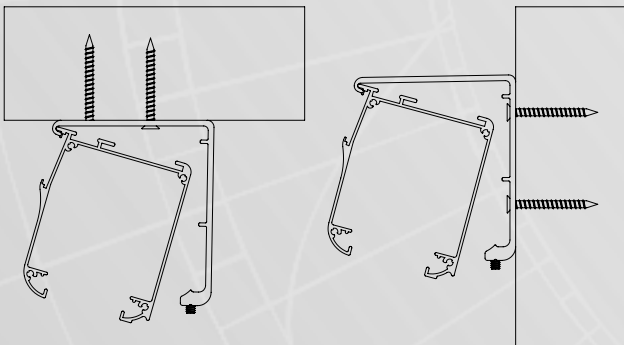

Wall and ceiling fixing is possible

ADJUSTING MOTOR

The limit settings for the tubular motors can be done as follows:

- S motors, mechanically by means of an allen key.
- E motors, electronically by means of a Forest Remote or RF Wall Switch.

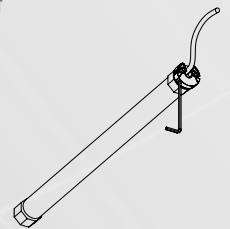



WORKS WITH

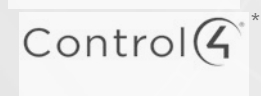
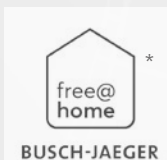

* Only works with actor.

Forest BCS® is compatible with many other Building Automation systems, thanks to its modular construction. A competitive advantage over other motorised drapery systems in the world!

CONTROL OPTIONS

Choose your preferred control option.

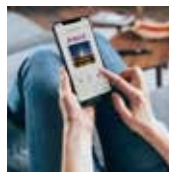

FOREST WIRELESS CONNECTOR

The Forest Wireless Connector provides an easy solution to make Forest motorised roman blinds 'smart.' When combined with a smart plug, you can effortlessly control the roman blinds through a mobile app. Controlling the motorised blind system by your smartphone or tablet, you can create and schedule customized room scenes that allow your blinds to operate on their own throughout the day.



Scan for more info

If you prefer to use the Forest Connect App, you can opt for Forest's smart plug. If you wish to operate your blinds with Apple HomeKit, Amazon Alexa, or Google Assistant, you will need a compatible third-party smart plug that works with these smart home apps. This RF device can also be seamlessly integrated into the most common building management systems, including systems with dry contacts.







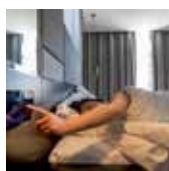



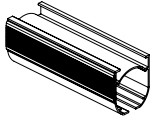

FOREST DIAMOND SENSE REMOTE

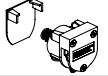
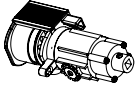

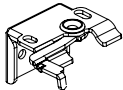
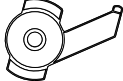
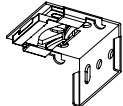
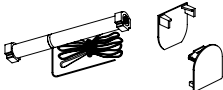
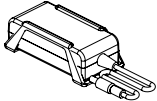
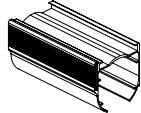
15 Channel remote control, possibility to control up to 15 systems individually and in group by integrated timer function or manual. Auto-On mode, when holding hand above it, the integrated LED light will automatically come on. Radio control, range up to 30 meters. Including magnetic wall support.

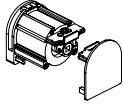
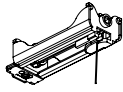
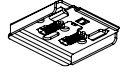

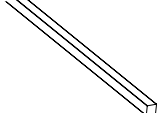



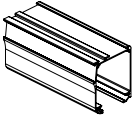

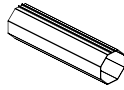
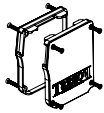
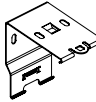
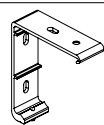
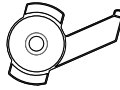
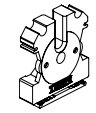
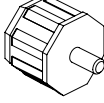
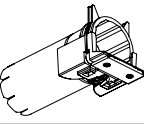
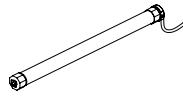
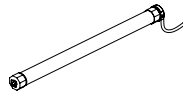
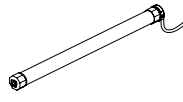
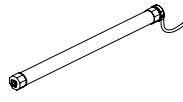
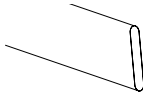
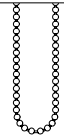





BUILDING AUTOMATION / HOTEL CONTROL

The BCS® system can be connected to any Building Automation system, by relay control. Also possible using the Wireless Connector.

| BS | | BCS | ARTICLE | PACKING UNIT | | ART.NR |
|----|---|-----|---|-------------------|------------------------|---|
| • | | |  <p>BS TRACK Extruded aluminium chromated white powder coated, with Velcro hook tape on front of the track. Available length: 5.8 mtr. (19 Ft.)</p>  | 58 mtr./bundle | white | 3601001580 |
| • | | |  <p>BS CONTROL UNIT 1:4, incl. endcap Heavy duty, Self-braking. Operation by chain. Weight capacity 7.5 kg</p> | 100/box | white | 3611001014-L |
| | | |  <p>BS CONTROL UNIT 1:1, incl. endcap Weight capacity 3.5 kg</p> | | | 3611001011-L |
| • | | |  <p>CHILD SAFETY CONTROL UNIT 1:4 Manual, incl. endcap</p>  | 100/box | white | 3611001000 |
| • | | |  <p>QUICKLOCK CORD ROLL incl. 3.5 mtr. cord (different color types cord available upon request, see for colour options BS/BCS Cord)</p> | 100/box | white/transparent | 3642401350 |
| | | | without cord | | | 364240000 |
| • | | |  <p>BS WALL BRACKET, SWIVEL Metal</p> | 100/box | white | 0 366300100 0 |
| • | | |  <p>BS CEILING BRACKET, SWIVEL</p> | 100/box | white | 3661000000 |
| • | | |  <p>BS SMART CLICK WALL / CEILING BRACKET Metal</p> | 100/box | white | 3662000000 |
| • | | |  <p>BS MOTOR 24V Double shaft motor including 2 end caps and integrated-receiver.</p> | 1/box | | 3648000000 |
| • | | |  <p>FOREST ADAPTOR FOR BS MOTOR Forest adaptor with support bracket for BS motor (without cable)</p> | 1/box | white | 5232003002 |
| | | | Cable with plug available in versions | 1/box | EU UK AUS USA | 520100110 1 520100113 1 520100114 |
| • | | |  <p>BS MAX TRACK Extruded aluminium chromated white powder coated, with Velcro hook tape on front of the track. Available length: 5,8 mtr (19 Ft.)</p>  | 46,4 mtr./bundle | white | 1 520100112 1 371000158 |
| • | | |  <p>BS MAX CONTROL UNIT 1:4 with endcap</p> | 50/box | white | 0711001014 |
| • | | |  <p>BS MAX CORD DRUM incl. 4,8 mtr. cord</p> | 50/box | white/transparent | 3711000480 |
| • | | |  <p>BS MAX HIDDEN CEILING BRACKET</p> | 50/box | white | 3711000000 |
| • | | |  <p>BS MAX L-CEILING /WALL BRACKET</p> | 100/box | white | 3711000001 |
| • | • | |  <p>BS ROD 5X5 MM ALUMINIUM Aluminium 5 x5 mm (0,20" x 0,20") Available length: 5,8 mtr (19 Ft.)</p> | 10/bundle | | 3630000580 |
| • | • | • |  <p>FIBEROD 6 meter length 4mm diameter</p> | 600 mtr. / bundle | | 3535301600 |

| BS | | BCS | ARTICLE | PACKING UNIT | | ART.NR |
|----|---|-----|---|--|---|--|
| | | • |  BCS TRACK Extruded aluminium chromated white powder coated Available Length 5,80 mtr (19 Ft.) | 500 mtr./roll | white | 3416101000 |
| | | • |  BCS VELCRO HOOK TAPE 25 mm height. 1,20 meter length | 1/box | white | 3416500004 |
| | | • |  BCS TUBE 8-ANGULAR Length 5,80 mtr (19 Ft.) | 1pc | white | 3416102000 |
| | | • |  BCS ENDCAPS LEFT/RIGHT | 25 sets/ box | white | 3416201000 |
| | | • |  BCS EASY MOUNT WALL / CEILING BRACKET For wall and ceiling fixing. | 25/box | white | 3416301010 |
| | | • |  BCS MOUNTING BRACKET WITH ALLEN SCREW For wall and ceiling fixing. | 25/box | white | 3416301020-B |
| | | • |  CEILING SWIVEL BRACKET For ceiling fixing. | 100/box | white | 3818200450 |
| | | • |  BCS CENTRE SUPPORT Dimension: 51 x 56 mm. | 25/box | | 3416500000 |
| | | • |  BCS TUBE SUPPORT 8-ANGULAR To be placed on the open end of the 8 angular tube. | 25/box | | 3416500003 |
| | | • |  BCS CORD DRUM COMPLETE Incl. 5.5 mtr white cord. | 25/box | | 3416500002 |
| | | • |  FOREST TUBULAR MOTOR Ø 35MM 6/28/S 13/14/S | 1/box | 230v/50hz 6nm/28rpm 230v/50hz 13nm/14rpm | 341660001 2 |
| | | • |  FOREST SILENT TUBULAR MOTOR Ø 35MM 6/20/SQ | 1/box | 230v/50hz 6nm/20rpm/SQ | 341660001 6 |
| | | • |  FOREST TUBULAR MOTOR Ø 35MM WITH INTERNAL RECEIVER 6/28/E 13/14/E | 1/box | 230v/50hz 6nm/28rpm 230v/50hz 13nm/14rpm | 341660011 2 |
| | | • |  FOREST SILENT TUBULAR MOTOR Ø 35MM WITH INTERNAL RECEIVER 6/20/EQ | 1/box | | 341660011 6 |
| | | • | COUNTER WEIGHT BAR 6 MTR | | 230v/50hz 6nm/20 rpm/EQ | 341660011 |
| • | • | • |  | 60 mtr./bundle 60 mtr./bundle 90 mtr./bundle 30 mtr./bundle | 6 x 20 mm white 3 x 25 mm white 3 x 40 mm white 5 x 25 mm white | 7 350170160 0 380140060 380140160 |
| • | • | • |  ROMAN BLIND CHAIN 6 MM PITCH METAL STAINLESS STEEL | roll 1/bag | rol 150 mtr 1.50 mtr (drop=0.75 mtr) 2.00 mtr (drop=1.00 mtr) 2.50 mtr (drop=1.25 mtr) 3.00 mtr (drop=1.50 mtr) 3.50 mtr (drop=1.75 mtr) 4.00 mtr (drop=2.00 mtr) 4.50 mtr (drop=2.25 mtr) | 367000810 380140260 367000815 0 367000820 0 367000825 0 367000830 0 367000835 0 367000840 0 |

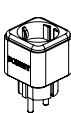
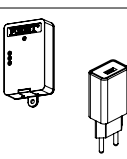
| BS | | BCS | ARTICLE | PACKING UNIT | | ART.NR |
|----|---|-----|---|---------------|--|--|
| • | • | |  ROMAN BLIND CHAIN 6 MM PITCH METAL | roll 1/bag | rol 150 mtr 1.50 mtr (drop=0.75 mtr) 2.00 mtr (drop=1.00 mtr) 2.50 mtr (drop=1.25 mtr) 3.00 mtr (drop=1.50 mtr) 3.50 mtr (drop=1.75 mtr) 4.00 mtr (drop=2.00 mtr) 4.50 mtr (drop=2.25 mtr) 5.00 mtr (drop=2.50 mtr) 6.00 mtr (drop=3.00 mtr) | 367000310 0 367000715 0 367000720 0 367000725 0 367000730 0 367000735 |
| • | • | |  ROMAN BLIND CHAIN 6 MM PITCH METAL MATT BLACK | roll | 1.00 mtr | 0 367000740 0 367000745 0 367000750 0 |
| • | • | |  ROMAN BLIND ENDLESS CHAIN 6 MM PITCH PLASTIC WHITE | 1/bag | 1.00 mtr (drop=0,50 mtr) 1.50 mtr (drop=0.75 mtr) 2.00 mtr (drop=1.00 mtr) 2.50 mtr (drop=1.25 mtr) 3.00 mtr (drop=1.50 mtr) 3.50 mtr (drop=1.75 mtr) 4.00 mtr (drop=2.00 mtr) 4.50 mtr (drop=2.25 mtr) 5.00 mtr (drop=2.50 mtr) 6.00 mtr (drop=3.00 mtr) | 367000260 0 367000210 0 367000215 0 367000220 0 367000225 0 367000230 0 367000235 |
| • | | |  CHAIN JOINTING PLIER For joining two ends of the metal chain together | 1/box | | 0 367000240 0 367000245 0 367000250 |
| • | • | |  CORD/CHAIN WALL MOUNT SAFETY BOX SINGLE | 25/box | | 0645702000 367000260 0 |
| • | | |  CORD/CHAIN WEIGHT DESIGN | 10/box | white grey black | 363590000 0 303070300 0 |
| • | | |  LOOP TAPE 20MM To be fixed onto the curtain fabric | 25 mtr./roll | | 303070600 0 381620202 |
| • | • | |  ROMAN BLIND CORD For use in combination with Cord Roll Support / Cord Drum. Thickness: 1.3 mm. | 500 mtr/roll | white (selection of 16 colours: White, corn, grey, off-white, brown, black, steel grey, old pink, mocca, beige, terra, moss, salmon, aubergine, green, pink) | 3645001000 0 |
| • | • | |  SNAP CORD FIXER For easy adjustment of the bottom side of the blind | 100/box | transparent | 3647001001 |
| • | | |  SNAP CORD FIXER CHILD SAFETY | 100/box | transparent | 3611001001 |
| • | • | |  FOREST WIRELESS WALL SWITCH 2 CHANNEL LED | 1/box | white black | 520100148 0 520100648 0 |
| • | • | |  FOREST MULTI RECEIVER WALL SWITCH For motor without internal receiver | 1/box | white | 5104011500 |
| • | • | |  FOREST DIAMOND SENSE REMOTE 15 CHANNEL INCL TIMER | 1/box | white black | 520109147 0 520108647 0 |
| • | • | |  FOREST WIRELESS CONNECTOR Incl.15cm USB cable excl. USB power plug One way transmitter to integrate system in Domotic System. To control by third apps like Google Home, Amazon Alexa or Apple Homekit use a (third-party) smart plug. | 1/box | white USB power plug EU USB power plug UK USB power plug AU USB power plug US | 5201002270 5201002271-EU 5201002271-UK 5201002272-AU 5201002274-US |
| • | • | |  FOREST SMART PLUG WHITE The Forest Smart Plug allows App control via the Forest Connect App (the Forest Wireless Con- nector is required) | 1/box | EU UK AU US | 5201001952-EU 5201001953-UK 5201001954-AU 5201001955-US |

BR0016EN231116

Live Better